



## BioCheck SARS-CoV-2 IgM Antibody Test Kit

### Instructions for Use

For Use under an Emergency Use Authorization (EUA) Only  
For Prescription Use Only  
For *in vitro* Diagnostic Use Only

**REF** BCM-1003

**IVD**

$\Sigma$  10



## Table of Contents

Symbols List .....	4
Intended Use .....	5
Background.....	5
Summary and Principles of the Procedure .....	6
Warnings and Precautions .....	7
Materials Provided .....	9
Kit Components.....	9
Components of the Test Cartridge.....	9
Materials Required But Not Provided .....	10
Reagent Storage, Handling and Stability.....	10
Sample Requirements.....	<u>1011</u>
Sample Collection and Preparation .....	<u>1011</u>
Sample Stability and Handling.....	11
Quality Control .....	11
External Controls (Positive and Negative Controls) .....	11
Positive and Negative Quality Control (QC) Testing .....	11
Procedure .....	<u>1415</u>
Sample Testing .....	<u>1415</u>
Interpretation of Results .....	15
Cut-Off.....	15
Valid Results .....	<u>1546</u>
Invalid Runs.....	<u>1546</u>
Limitations of the Procedure.....	<u>1546</u>
Conditions of Authorization for the Laboratory .....	<u>1617</u>
Performance Characteristics .....	<u>1748</u>
Clinical Performance .....	<u>1748</u>
Analytical Performance.....	<u>1819</u>
Cross-Reactivity.....	<u>1819</u>
Interference.....	<u>1920</u>
Reproducibility .....	<u>1920</u>
References .....	<u>2021</u>



**BioCheck, Inc.**

425 Eccles Avenue  
South San Francisco, CA 94080 USA  
Tel: (650) 573-1968  
Fax: (650) 573-1969  
[www.biocheckinc.com](http://www.biocheckinc.com)



**Accelerate Diagnostics, Inc.**

3950 S. Country Club Road, Suite 470  
Tucson, AZ 85714 USA  
E-mail: [support@axdx.com](mailto:support@axdx.com)  
Technical Support: 1-888-586-2939  
Fax: 1-520-269-6580  
[www.axdx.com](http://www.axdx.com)















**Most Recent Labeling Documents**



[www.adx.com/support](http://www.adx.com/support)  
Keycode: ADX15343

## Symbols List

The following symbols may appear on the product labels or instructions for use.

Symbol	Description	Symbol	Description
	In vitro diagnostic equipment		Catalog Number
	Batch Code	<b>SN</b>	Serial Number
	Power on	○	Power off
	Do Not Re-Use		Contains Sufficient for <n> Tests
<b>CE</b>	CE-Marking of Conformity	<b>EC REP</b>	Authorized Representative in the European Community
	Temperature Limit		Use-By Date
	Consult Electronic Instructions for Use	<b>Rx only</b>	Caution: Federal law restricts this device to sale by or on the order of a licensed healthcare practitioner
	Manufacturer		Date of Manufacture
	Distributor		Importer
	High temperature, do not touch these areas		Biological hazard
	Caution: General Warning		



**For Use Under Emergency Use Authorization Only**  
**For *in vitro* diagnostic use.**  
**For prescription use only.**

## Intended Use

The BioCheck SARS-CoV-2 IgM Antibody Test Kit is a chemiluminescent immunoassay intended for the qualitative detection of IgM antibodies to SARS-CoV-2 in human serum using the MS-Fast Automated Chemiluminescent Immunoassay Analyzing System.

The BioCheck SARS-CoV-2 IgM Antibody Test Kit is intended for use as an aid in identifying individuals with an adaptive immune response to SARS-CoV-2, indicating recent or prior infection. At this time, it is unknown for how long antibodies persist following infection and if the presence of antibodies confers protective immunity. The BioCheck SARS-CoV-2 IgM Test should not be used to diagnose acute SARS CoV-2 infection.

Testing is limited to laboratories certified under the Clinical Laboratory Improvement Amendments of 1988 (CLIA), 42 U.S.C. §263a, that meet requirements to perform moderate or high complexity tests.

Results are for the detection and differentiation of SARS-CoV-2 IgM antibodies. The IgM antibodies to SARS-CoV-2 are generally detectable in blood several days after initial infection, although the duration of time antibodies are present post-infection is not well characterized. Individuals may have detectable virus present for several weeks following seroconversion.

Laboratories within the United States and its territories are required to report all results to the appropriate public health authorities.

The sensitivity of BioCheck SARS-CoV-2 IgM Antibody Test Kit early after infection is unknown. Negative results do not preclude acute SARS-CoV-2 infection. If acute infection is suspected, direct testing for SARS-CoV-2 is necessary.

False positive results for BioCheck SARS-CoV-2 IgM Antibody Test Kit may occur due to cross-reactivity from pre-existing antibodies or other possible causes. Due to the risk of false positive results, confirmation of positive results should be considered using a second, different IgM assay.

The BioCheck SARS-CoV-2 IgM Antibody Test Kit is only for use under the Food and Drug Administration's Emergency Use Authorization.

## Background

Severe Acute Respiratory Syndrome Coronavirus 2 (SARS-CoV-2) is a new virus strain that has not been previously identified in humans and belongs to the coronavirus subfamily of the Coronaviridae family. Although it has better sequence conservation compared with the SARS virus in 2003 and MERS virus in 2012, it has low structural homology in the partial protein primary structure of the 19 proteins encoded. Combined with the recently published epidemiological and toxicological evidence, it is suggested that SARS-CoV-2 belongs to a relatively specific coronavirus, and current research shows that the new virus has more than 85% homology with bat SARS-like coronavirus (bat-SL-CoVZC45). This bat SARS-like coronavirus presents the characteristics of strong infection ability, fast transmission speed, and a large number of infections.



SARS-CoV-2 is highly contagious, and the human population is generally susceptible. It is mainly transmitted through respiratory droplets and contact routes, and the virus infects human cells via binding to angiotensin converting enzyme 2 (ACE2).<sup>1,2</sup> People who are infected with SARS-CoV-2 may be asymptomatic or express signs and symptoms of lower respiratory tract infection such as dry cough, fever, and dyspnea (shortness of breath). In severe cases, the virus can cause acute respiratory distress syndrome (ARDS) and sepsis. Symptomatic, pre-symptomatic, and asymptomatic SARS-CoV-2 carriers all can be potential sources for viral transmission.<sup>3</sup> Real-time reverse transcription polymerase chain reaction (rRT-PCR) detection of viral genes is the current gold standard for the diagnosis of COVID-19. Upper respiratory specimens, such as nasopharyngeal swabs and oropharyngeal swabs, are commonly used for diagnostic testing.<sup>2</sup>

The potential public health threat posed by COVID-19 is high, both globally and to the United States. To respond effectively to the COVID-19 outbreak, rapid detection of cases and contacts, appropriate clinical management and infection control, and implementation of community mitigation efforts are critical.

The BioCheck SARS-CoV-2 IgM Antibody Test Kit is intended for the qualitative detection of antibodies which could be indicative recent or prior infection.

## Summary and Principles of the Procedure

The BioCheck SARS-CoV-2 IgM Antibody Test Kit uses an indirect method to determine the presence of SARS-CoV-2 IgM and antibodies in a human serum.

In the cassette from the IgM component of the kit, the SARS-CoV-2 IgM antibodies in a patient serum sample bind to biotinylated SARS-CoV-2 S1 antigens. Excess streptavidin coated magnetic beads bind with high affinity to biotinylated SARS-CoV-2 S1 antigen to form complexes. After incubation at 37°C for 10 minutes, the non-specific components in the serum are removed by washing. Next, alkaline phosphatase labeled anti-human IgM antibodies are added to the complexes for incubation at 37°C for 10 minutes, during which time the anti-human IgM antibodies bind to the complexes. This is followed by a second wash to remove excess alkaline phosphatase labeled anti-human IgM antibodies. A luminescent substrate is added, and the enzymes in the complexes catalyze the luminescent substrate to form unstable excited state intermediates. When the excited intermediates return to the ground state, photons are emitted. The number of photons produced is positively correlated with the level of SARS-CoV-2 IgM antibodies in the sample. The more SARS-CoV-2 IgM antibodies present in the sample, the more IgM antibodies that are captured and enzyme-labeled. Producing more enzymes to catalyze substrates, during which more photons (RLU) will be produced. The number of photons (RLU) produced is directly correlated with the level of SAR-CoV-2 IgM antibodies in the sample.

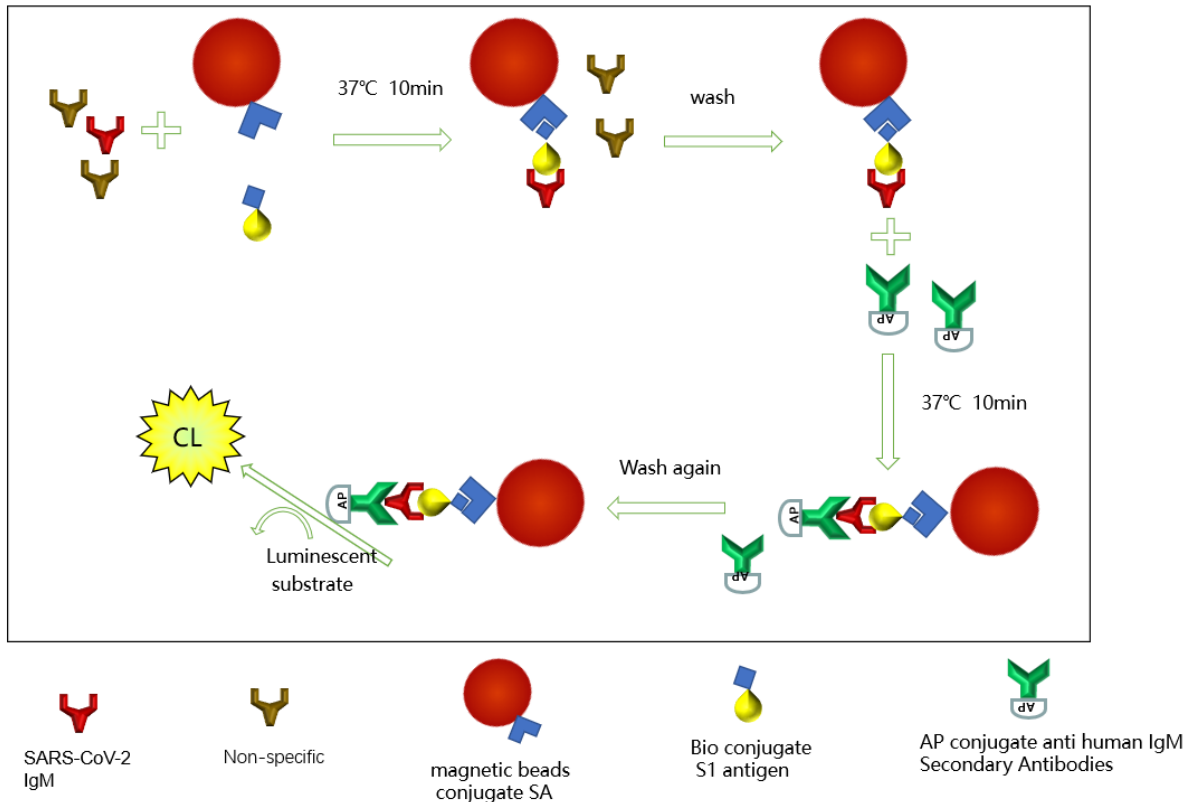

Figure 1: Schematic Diagram of the Reaction Principle of BioCheck SARS-CoV-2 IgM Antibody Test Kit

## Warnings and Precautions

### General Precautions

- For *in vitro* diagnostic use under the FDA Emergency Use Authorization.
- For Prescription Use Only
- For *in vitro* Diagnostic Use Only
- *Caution:* Federal Law restricts this device to sale by or on the order of a licensed practitioner.
- This test has not been FDA cleared or approved; this test has been authorized by FDA under an EUA for use by laboratories certified under CLIA and meet requirements to perform moderate or high complexity tests.
- This test has been authorized only for the presence of IgM antibodies against SARS-CoV-2, not for any other viruses or pathogens.
- This test is only authorized for the duration of the declaration that circumstances exist justifying the authorization of emergency use of *in vitro* diagnostic tests for detection and/or diagnosis of COVID-19 under Section 564(b)(1) of the Act, 21 U.S.C. § 360bbb-3(b)(1), unless the authorization is terminated or revoked sooner.
- Laboratories within the United States and its territories are required to report all results to the appropriate public health authorities.



- Negative results do not rule out acute SARS-CoV-2 infection, particularly in those who have been in contact with the virus. Testing with a molecular diagnostic should be performed to evaluate for acute infection in symptomatic individuals.
- The BioCheck SARS-CoV-2 IgM Antibody Test Kit is intended for single use only. Do not reuse.
- Positive results may be due to past or present infection with non-SARS-CoV-2 coronavirus strains, such as coronavirus HKU1, NL63, OC43, or 229E.
- Consider any materials of human origin as infectious and handle using standard biosafety procedures. No test method can offer complete assurance that hepatitis B virus, hepatitis C virus (HCV), human immunodeficiency virus (HIV 1+2) or other infectious agents are absent.
- Handle, use, store, and dispose of solid and liquid waste from samples and test components in accordance with procedures defined by appropriate national biohazard safety guidelines or regulations.
- The entire test procedure should be performed according to general biosafety guidelines of clinical labs. Protect cuts, abrasions and other skin damages and mucosa from contamination and infection.
- The BioCheck SARS-CoV-2 IgM Antibody Test Kit contain ProClin 300 (CAS 55965-84-9), which may cause an allergic skin reaction. Wear protective gloves when handling the kits. If skin contact occurs, wash with plenty of soap and water. If skin irritation or rash occurs, get medical advice/attention. Wash contaminated clothing before reuse.
- Do not substitute or mix reagents from different kit lots or from other manufacturers. In each kit, sufficient quantities of each component are provided.
- Test result of the same sample using kits from different manufacturers may have variations due to differences in factors such as methodology or antibody specificity.
- Contaminated or suspected contaminated serum specimens or reagents can produce erroneous results.
- Testing must comply with standard laboratory guidelines to prevent cross-contamination.
- Do not use kit after the expiration date.
- Read the package insert and operation manual carefully prior to performing test.

### **Safety Precautions**

- Trained, qualified laboratory personnel should wear appropriate protective gear (gloves, lab coat, safety goggles) and exercise standard precautions for handling and disposing of infectious or potentially infectious materials (e.g. patient samples or consumables).
- All human source materials used in the preparation of the negative control have tested negative for antibodies to HIV 1&2, Hepatitis C and Hepatitis B surface antigen. However, no test method can ensure 100% efficiency. Therefore, all human controls and antigen should be handled as potentially infectious material. The Centers for Disease Control and Prevention and the National Institutes of Health recommend that potentially infectious agents be handled at the Biosafety Level 2.
- Materials used in the tests, including reagent cartridges and the sample collection device, should be disposed of according to federal, state and local regulations.
- Safety Data Sheets (SDS) are available upon request. If the product is a kit or is supplied with more than one component, please refer to the SDS for each component for hazard information.





**CAUTION:** You must have read and understood the contents of the instructions for use before attempting to run this assay. The contents of this document may be modified by BioCheck at any time. Check [www.biocheckinc.com](http://www.biocheckinc.com) for the latest information.

## Materials Provided

The BioCheck SARS-CoV-2 IgM Antibody Test Kit contains the following materials sufficient to perform ten (10) tests.

### Kit Components

Table 1. Key Components of the SARS-CoV-2 IgM Antibody Test Kit

Kit Components	Quantity	Description
Cartridge	10 IgM cartridges	See Table 2.
Positive Control IgM	200 $\mu$ L $\times$ 1	BSA-containing buffer with human SARS-CoV-2 S1 IgM antibody. Batch specific
Negative control IgM	200 $\mu$ L $\times$ 1	BSA-containing buffer. Batch specific
QR code label	label	Contain positive controls and negative control reference values for IgM on the side of the kit box

### Components of the Test Cartridge

The BioCheck SARS-CoV-2 IgM Antibody Test Kit cartridges (Figure 2) contain all the reagent components and accessories needed to run a test as shown in Table 2.

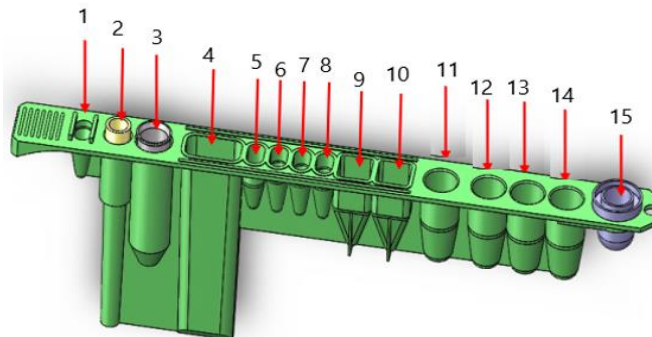

Figure 2. Schematic Diagram of Cartridge

Table 2. Components of the BioCheck SARS-CoV-2 IgM Antibody Test Kit Cartridges

#	Test Cartridge Components	Quantity	Main Composition
1	Sample Well	1	N/A
2	Pipette tip	1	N/A
3	Eluting sleeve	1	N/A
4	Wash buffer	4mL	0.95% Tween-20, 0.17%, Proclin 300 in Tris buffer
5	Luminescent substrate	180 $\mu$ L	APS-5 substrate
6	Magnetic separation reagent	60 $\mu$ L	Streptavidin labeled magnetic beads in PBS buffer

#	Test Cartridge Components	Quantity	Main Composition
7	Reagent A	80µL	Biotinylated SARS-CoV-2 S1 antigen, 0.1% Proclin 300 in Tris buffer
8	Reagent B IgM	130µL	ALP labeled Anti-human IgM antibody, 0.1% Proclin 300 in Tris buffer
9	Sample diluent	540µL	0.9% NaCl in buffer
10	Sample diluent	405µL	0.9% NaCl in buffer
11	Empty	N/A	Reaction Well
12	Empty	N/A	Wash Well
13	Empty	N/A	Wash Well
14	Empty	N/A	Reaction Well
15	Reading aperture	1	N/A

### Materials Required But Not Provided

**REF** T-1001 MS Fast Chemiluminescent Immunoassay Analyzing System (MS Fast Analyzer) manufactured by Sophonix Co., Ltd. in Beijing, China

- Micropipette and tips for sample addition
- Sample collection materials and centrifuge

### Reagent Storage, Handling and Stability

Proper storage and handling of reagents and samples are essential for the performance of the BioCheck SARS-CoV-2 IgM a Antibody Test Kits.

- Inspect package upon arrival. Kit components should be intact and complete with no leaking, damage, or contamination. All labels should be legible.
- If the foil seals are pierced, do not use the test cartridge.
- Remove kit from the shipping box and immediately store in a dark environment at temperatures between 2-8°C.
- Positive and negative controls are stable for 7 days at 2-8°C after opening.
- Test must be used immediately after opening.
- Do not use the kit after the expiration date. See the packaging label for the product expiration date.

### Sample Requirements

#### Sample Collection and Preparation

- The BioCheck SARS-CoV-2 IgM Antibody Test Kit should only be performed on human serum samples.
- Collect specimens using universal precautions.<sup>4</sup>
- Follow recommended procedures for collection of diagnostic blood specimens by venipuncture.<sup>5</sup>
- Follow instructions provided with your collection device for use and processing of the sample.<sup>6</sup>
- Ensure that complete clot formation in specimens has taken place prior to centrifugation.<sup>7</sup>
- Carefully transfer serum to a tightly sealed sterile container for storage.<sup>7</sup>



- Avoid use of icteric, hyperlipemic, hemolyzed, or contaminated sera which may cause erroneous results.

### Sample Stability and Handling

- Serum samples should be tested within 4 hours at room temperature (approximate range 15-30°C (59-86°F)) after blood collection. If testing cannot be performed immediately, store the serum samples at 2-8°C for up to 24 hours.
- For long-term storage, store small aliquots of samples below -20°C. Avoid repeated freeze/thaw cycles of aliquots. Freeze-thaw damage can result if specimens are frozen in self-defrosting freezers. Thaw and mix samples well prior to use.

## Quality Control

### External Controls (Positive and Negative Controls)

QC should be performed upon receipt of each new lot or shipment. The detected positive control Relative Light Units (RLU) will be calculated with the standard RLU of the positive control in the QR code to obtain a correction coefficient ( $M$ ,  $M = b / a$ ). If the RLU of the negative control after correction by the correction coefficient falls within the specified range of the negative control, the correction proved to be accurate, thus reducing the error caused by different instruments.

The RLU of the sample corrected by the correction coefficient is compared with the cut-off value of the product, and the result is judged to be negative or positive. The above calculation process will be completed automatically by MS-Fast Analyzer, and the result will be reported. The negative and positive controls should result in negative and positive test results, respectively.

If the quality control test results of the positive or negative controls are not within the expected range, repeat the failed control test under the same conditions. A new QC test should be run to obtain the expected positive or negative result. If QC test failure persists, stop using the kit lot and contact the U.S distributor, Accelerate Diagnostics.

### Positive and Negative Quality Control (QC) Testing

1. A rack of QC cartridges will take 30 minutes from test start until result acquisition.
2. Unpack the BioCheck SARS-CoV-2 Antibody Test Kit QC contents and equilibrate all materials to room temperature (15-30° C (59-86°F)) before use.
3. Insert four cartridges (two cartridges for positive controls, two cartridges for negative controls) into the reagent rack.

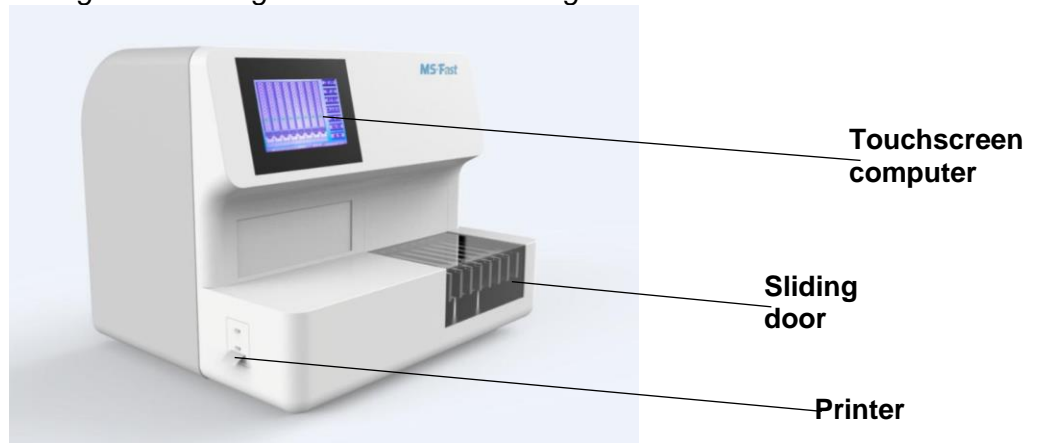

*Figure 3: Inserting Controls Cartridges into Reagent Rack*

- Using a micropipette with a fresh tip for each control, add 80 $\mu$ L of the appropriate controls to the corresponding sample wells of the cartridges.

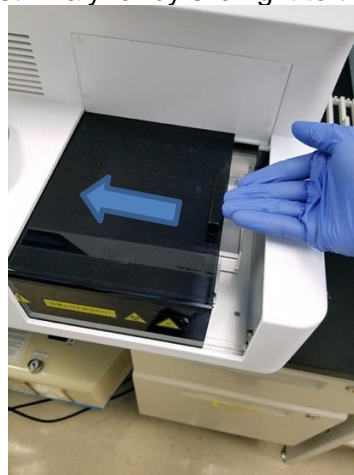

*Figure 4: Adding Controls to the Cartridge*



*Figure 5: MS Fast Analyzer*

- Open the door of the MS Fast Analyzer by sliding it to the left as shown in Figure 6.



*Figure 6: Opening Instrument Door*

6. Insert the reagent rack, then close the sliding door as shown in Figure 7.

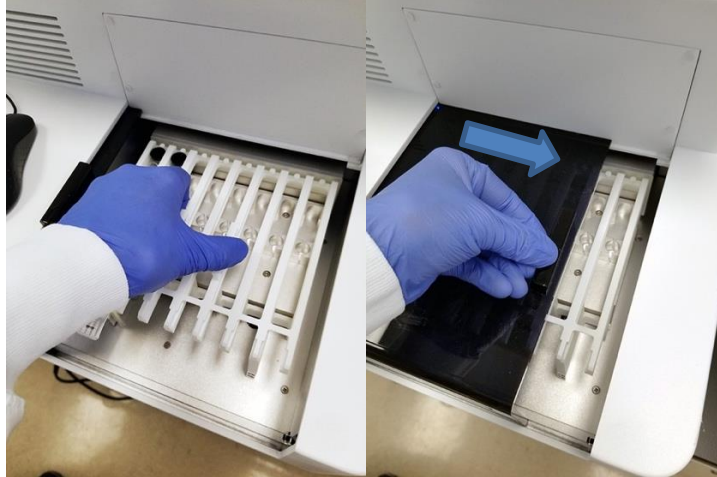

Figure 7: Inserting Rack and Closing Instrument Door



**NOTE:** The test result of the Negative Control must be negative (-) and the test result of the Positive Control must be positive (+). Otherwise, the kit is invalid, and troubleshooting is necessary to ensure proper function of the instrument reagents, control materials, or parameter settings.

NOTE: If this is the first time the lot or shipment is run:

- a. From the Main Window, select “Setting”.
  - b. In the Setting Window, select “Reagent Management”.
  - c. Select “SARS-CoV-2 IgM”.
  - d. Click “New batch”.
  - e. Scan each of the QR code labels on the side of the box with the handheld scanner. If the label cannot be scanned, the information can be manually input using the “Manual Input” button.
  - f. Select “Save Data”.
  - g. Repeat for the other antibody kit. Click “Back” when both QR code labels’ information has been saved.
7. From the “Run” screen, double click column corresponding to the cartridge position.
  8. Confirm the detected position is correct, then select the project name, lot number, and sample type (i.e., QC).
  9. Select positive or negative control and then click “Confirm”. The system will populate the required fields for IgM. Repeat until all controls have been entered.
  10. Click “Run” on the Home screen. The MS-Fast Analyzer will automatically identify the test project. When the run is complete, the QC results will automatically print. The QC report can be exported and reprinted.
  11. The MS-Fast report will indicate whether the control is valid or not. If the control is valid, the serum sample can be tested next. If the control is not valid, cause for the invalid control should be determined. See the MS-Fast User Manual for more information.

The expected test results for valid negative and positive controls are given below in Table 3.

*Table 3. Expected RLU of IgM Positive and Negative Controls for Valid Runs*

IgM Control	RLU	Interpretation and Next Steps
If both QC Negative Controls	<16,000	Valid QC Result
If one QC Negative Control	<16,000	Invalid QC Result. Repeat in duplicate
	≥16,000	
If both QC Negative Controls	≥16,000	Invalid QC Result. Repeat in duplicate
If both QC Positive Control	20,000 to 130,000	Valid QC Result
If one QC Positive Control	<20,000 or >130,000	Invalid QC Result. Repeat in duplicate
	20,000 to 130,000	
If both QC Positive Control	<20,000 or >130,000	Invalid QC Result. Repeat in duplicate



**NOTE:** When the negative QC and/or positive QC is not within range of the expected Relative Light Unit (RLU), the instrument should not be used to test samples. The QC should be repeated and if the QC fails again, please contact Accelerate Diagnostics Technical Support. The negative and positive controls should show correct results in order to have valid runs.

## Procedure

### Sample Testing

1. A rack of samples will take 30 minutes from test start until result acquisition.
2. The instrument can run up to eight samples at a time.
3. Unpack the IgM test cartridges and equilibrate all materials to room temperature (15-30° C (59-86°F) before use. Return all unused reagents to the refrigerator.
4. Insert one cartridge for each sample into the reagent rack. Ensure that test strips are locked into the rack (user should hear a click when inserted properly).
5. Using a micropipette, add 80µL serum to the sample well of each cartridge as shown in Figure 8.

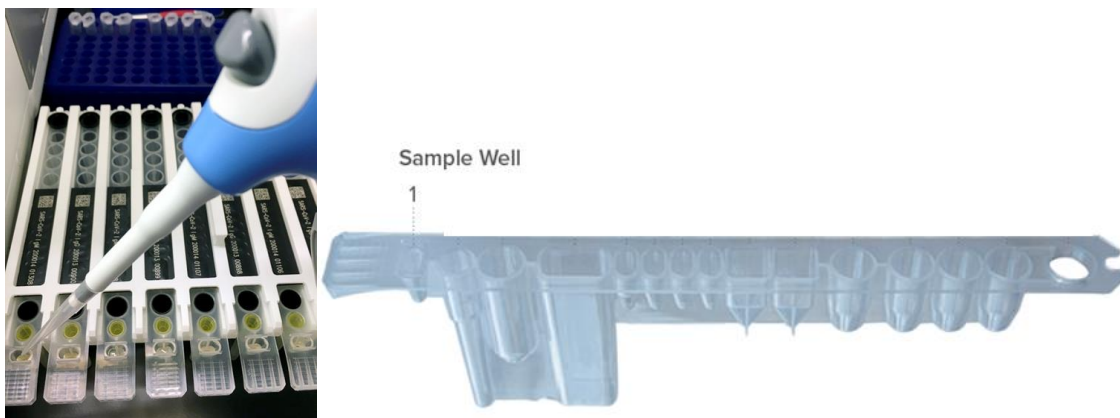

*Figure 8: Test Cartridge Showing Sample Well*

6. Slide door of the instrument to the left to open.
7. Insert the reagent rack.



8. From the Sample screen select the SARS-CoV-2 IgM project icon.
9. If using patient or sample barcodes, highlight the “Scan” field and scan in the unique patient (or sample) identifier barcodes using the external barcode scanner. Scan each barcode in the order of the samples in the rack. Click “Exit”.
10. If using manual sample entry, enter the number of samples to test in the “Sample #” field.
11. Push “add data” and double click the “Sample ID” field to manually edit the “Sample ID” field.
12. Click “Done” when complete and then click “Exit”.
13. Close the sliding door and click on “Run”. The MS-Fast Analyzer will automatically identify the test project and provide the final result when testing is complete.

## Interpretation of Results

### Cut-Off

The BioCheck SARS-CoV-2 IgM Antibody Test Kit assay uses the receiver operating characteristic (ROC) curve method to determine the positive cut-off value based on a selection of 157 clinically diagnosed serum specimens, including 52 positive serum samples and 105 negative serum samples. Statistical processing was performed to obtain the ROC curve, and the point with the largest Youden index was selected as the critical point, which is the positive cut-off value of the kit. The RLU corresponding to the SARS-CoV-2 IgM cut-off is 18500. When the RLU of the sample test result is  $\geq 18500$ , the result is positive. When the RLU of the sample test result is  $< 18500$ , the result is judged as negative.

### Valid Results

The MS-Fast Analyzer produces the test result when the assay run is complete. Patient sample test results should only be interpreted if the QC test result was valid. The expected test results for valid negative and positive QC results are given in Table 4.

*Table 4. Interpretation*

IgM Test		Test Result Interpretation
Result Reported	RLU Expected	
Positive	$\geq 18500$	Positive for SARS-CoV-2 IgM antibodies
Negative	$< 18500$	Negative for SARS-CoV-2 IgM antibodies

### Invalid Runs

When the negative control or positive control is not within range of the expected RLU, the test result is not valid and, therefore, the assay should not be used to report results. The positive and negative controls should show passing results prior to running patient specimens.

## Limitations of the Procedure

- The product can only be used with MS-Fast Automated Chemiluminescent Immunoassay Analyzing System.
- The BioCheck SARS-CoV-2 IgM Antibody Test Kit has not been evaluated for specimens other than human serum.
- Samples that are contaminated or suspected of contamination cannot be used for testing.



- The assay should not be used to diagnose or exclude acute infection. Results are not intended to be used as the sole basis for patient management decisions.
- Negative results do not preclude SARS-CoV-2 infection and should not be used as the sole basis for patient management decisions.
- A negative or non-reactive result can occur if the quantity of antibodies for the SARS-CoV-2 virus present in the specimen is below the detection limit of the assay, or the virus has undergone minor amino acid mutation(s) in the epitope recognized by the antibody detected by the test.
- The clinical significance of the test results of the kit needs to be analyzed in combination with other test indicators and clinical manifestations.
- A positive result may not indicate previous SARS-CoV-2 infection. Consider other information, including clinical history and local disease prevalence, in assessing the need for a second, alternative serology test to confirm an immune response.
- It is not known at this time if the presence of antibodies to SARS-CoV-2 confers immunity to reinfection.
- Assay performance characteristics have not been established for testing cord blood, for testing neonates, for prenatal screening, or for general population screening.
- Results from immunosuppressed patients must be interpreted with caution.
- Failure to observe proper procedures for sample collection, preparation, storage, handling, and/or transportation may cause incorrect results.
- The kit has not been tested with all types of blood collection tubes that are commercially available. For different blood collection tubes from different manufacturers, different results may be obtained due to different raw materials and additives.
- Not for the screening of donated blood.

## Conditions of Authorization for the Laboratory

The BioCheck SARS-CoV-2 IgM Antibody Test Kit Letter of Authorization, along with the authorized Fact Sheet for Healthcare Providers, the authorized Fact Sheet for Patients, and authorized labeling are available on the FDA website:

<https://www.fda.gov/medical-devices/coronavirus-disease-2019-covid-19-emergency-use-authorizations-medical-devices/vitro-diagnostics-euas>

Authorized laboratories using the BioCheck SARS-CoV-2 IgM Antibody Test Kit must adhere to the Conditions of Authorization indicated in the Letter of Authorization as listed below:

- Authorized laboratories<sup>a</sup> using the BioCheck SARS-CoV-2 IgM Antibody Test Kit will include with test result reports, all authorized Fact Sheets. Under exigent circumstances, other appropriate methods for disseminating these Fact Sheets may be used, which may include mass media.
- Authorized laboratories will use the BioCheck SARS-CoV-2 IgM Antibody Test Kit as outlined in the authorized labeling. Deviations from the authorized procedures, including the authorized clinical specimen types, authorized control materials, authorized other ancillary reagents and authorized materials required to use the product are not permitted.
- Authorized laboratories that receive the BioCheck SARS-CoV-2 IgM Antibody Test Kit will notify the relevant public health authorities of their intent to run the assay prior to initiating testing.





- Authorized laboratories using the BioCheck SARS-CoV-2 IgM Antibody Test Kit will have a process in place for reporting test results to healthcare providers and relevant public health authorities, as appropriate.
- Authorized laboratories will collect information on the performance of the BioCheck SARS-CoV-2 IgM Antibody Test Kit and report to DMD/OHT7-OIR/OPEQ/CDRH (via email: CDRH.EUA.Reporting@fda.hhs.gov) and Biocheck Technical Support (<https://BioCheckInc.com>) any suspected occurrence of false reactive or false non-reactive results and significant deviations from the established performance characteristics of the assay of which they become aware.
- All laboratory personnel using the BioCheck SARS-CoV-2 IgM Antibody Test Kit must be appropriately trained in immunoassay techniques and use appropriate laboratory and personal protective equipment when handling this kit, and use the BioCheck SARS-CoV-2 IgM Antibody Test Kit in accordance with the authorized labeling. All laboratory personnel using the assay must also be trained in and be familiar with the interpretation of results of the the BioCheck SARS-CoV-2 IgM Antibody Test Kit.
- BioCheck Inc., authorized distributors, and authorized laboratories using the BioCheck SARS-CoV-2 IgM Antibody Test Kit will ensure that any records associated with this EUA are maintained until otherwise notified by FDA. Such records will be made available to FDA for inspection upon request.

<sup>a</sup> The letter of authorization refers to, "Laboratories certified under the Clinical Laboratory Improvement Amendments of 1988 (CLIA), 42 U.S.C. §263a, that meet requirements to perform moderate and high complexity tests" as "authorized laboratories".

## Performance Characteristics

### Clinical Performance

Clinical studies were conducted using a total of two hundred fifty-three (253) patient samples obtained from China and the United States. One hundred fifty-three (153) of the samples were collected from individuals at two clinical trial institutions in China. Of the 153 samples, 110 had tested positive for SARS-CoV-2 and the other 43 samples tested negative for SARS-CoV-2, both using a comparator PCR testing method. An additional one hundred (100) known negative samples collected in the United States prior to December 2019 from a biobank tested negative for SARS-CoV-2 using a comparator PCR testing method.

For the 110 positive samples obtained from clinical trial institutions in China, 105 IgM test results were positive. For the 143 negative samples, comprising 43 pre-pandemic samples from China and 100 pre-pandemic samples from the United States, 139 IgM test results were negative.

By comparing with the diagnostic results of a nucleic acid detection method, the positive percent agreement (PPA) and negative percent agreement (NPA) of the BioCheck SARS-CoV-2 IgM Antibody Test Kit were determined and shown in Table 5 and Table 6.

Table 5. IgM PPA

Days Post Symptom Onset	# PCR Positive At Any Time	BioCheck SARS-CoV-2 IgM Antibody Test Kit		
		# Of Positive Results	PPA	95%CI
≤7	7	7	100%	64.57% -100%
8-14	16	15	93.75%	71.67% - 98.89%
≥15	9	8	88.89%	56.50% - 98.01%
unknown	78	75	96.15%	89.29% - 98.68%

**Overall IgM PPA: 95.45% (105/110); [95% (89.80% - 98.04%)]**

Table 6. IgM NPA

# PCR Negative	BioCheck SARS-CoV-2 IgM Antibody Test Kit		
	# Of Negative Results	NPA	95%CI
143	139	97.20%	93.0% - 99.2%

## Analytical Performance

### Cross-Reactivity

Cross-reactivity of the BioCheck SARS-CoV-2 IgM Antibody Test Kit was evaluated by judging positive and negative results of specimens serologically positive for other known coronaviruses, respiratory pathogens (both bacterial and viral), and other blood-borne pathogens against the SARS-CoV-2 IgM test.

No cross-reactivity was detected when anti-sera for the following infectious agents was tested on the SARS-CoV-2 IgM test: Human coronavirus panel 229E/HKU1, Human coronavirus panel OC43/NL63, Parainfluenza 1, Parainfluenza 3, Parainfluenza 4, Adenovirus, Rhinovirus, *Mycoplasma pneumonia*, HBV, HCV, Influenza A, Influenza B, and Respiratory Syncytial Virus.

Table 7. Cross-Reactivity

Conditions	Number of Samples
anti-influenza A IgM	5
anti-influenza B IgM	5
anti-HCV IgM	5
anti-HBV IgM	5
anti-Haemophilus influenzae IgM	5
Human coronavirus panel 229E/HKU1	5
Human coronavirus panel OC43/NL63	5
ANA	5
anti-respiratory syncytial virus IgM	5

In addition, one hundred (100) known negative samples were collected in the US prior to December 2019 from a population with a high prevalence of vaccination and/or infection and were tested to evaluate potential cross-reactivity. The specificity of IgM test was 96%.

### Interference

Low titer SARS-CoV-2 IgM antibody positive serum samples and SARS-CoV-2 IgM antibody negative serum samples were spiked with one of the following substances to specified concentrations. No false-positivity or false-negativity was found.

*Table 8. Interference*

Interfering Substance	Concentration IgM
Hemoglobin	10 mg/mL
Bilirubin, conjugated	0.4 mg/mL
Bilirubin, unconjugated	0.4 mg/mL
Triglycerides	15 mg/mL
Cholesterol	4 mg/mL
Human anti-mouse antibody	800 ng/mL
Rheumatoid factor	2000 IU/mL
Human serum albumin	60 mg/mL
Histamine hydrochloride	4 mg/mL
α-IFN	200 mg/L
Zanamivir	1 mg/L
Oseltamivir carboxylate	1 mg/L
Abidol	40 mg/L
Levofloxacin	200 mg/L
Ceftriaxone	400 mg/L
Meropenem	200 mg/L
Tobramycin	10 mg/L
Ribavirin	40 mg/L
Biotin	3500 ng/mL

### Reproducibility

For the BioCheck SARS-CoV-2 IgM Antibody Test Kit, five (5) positive samples and two (2) negative samples, respectively, were selected and each sample was tested in duplicate by two (2) different operators at two (2) different labs with three (3) different lots/batches of kits for five (5) consecutive days, resulting in a total of 30 test results per sample. Inter/ intra assay, inter-lab, and inter-lot reproducibility was determined and shown in Table 9.

Table 9. IgM Reproducibility

Sample ID	Mean Value	N	Inter- assay		Intra-assay		Between-Days		Between-Lot		Total Precision	
			SD	%CV	SD	%CV	SD	%CV	SD	%CV	SD	%CV
Low Positive	25489	30	1845	7.24	1838	7.16	266	1.04	1821	7.15	2053	8.1
Moderate Positive	83086	30	5405	6.51	4182	5.07	2308	2.78	5379	6.47	5504	6.6
High Positive	203001	30	15794	7.78	12383	6.15	8783	4.33	14595	7.19	18413	9.1
Positive	112485	30	8943	7.95	8224	7.30	2185	1.94	8875	7.89	9708	8.6
Positive	65574	30	5312	8.10	4741	7.24	2419	3.69	5377	8.20	5620	8.6
Negative	5674	30	375	6.60	319	5.64	176	3.10	387	6.82	406	7..2
Negative	14027	30	879	6.27	801	5.72	268	1.91	878	6.26	930	6.6

## References

1. Modes of transmission of virus causing COVID-19: implications for IPC precaution recommendations (<https://www.who.int/news-room/commentaries/detail/modes-of-transmission-of-virus-causing-covid-19-implications-for-ipcprecaution-recommendations>)
2. IFCC Information Guide on COVID-19 (<https://www.ifcc.org/ifcc-news/2020-03-26-ifcc-information-guide-on-covid-19/>)
3. Lai et al. Severe acute respiratory syndrome coronavirus 2 (SARS-CoV-2) and coronavirus disease-2019 (COVID-19): The epidemic and the challenges. *International Journal of Antimicrobial Agents*. 55:3; 2020.
4. Clinical and Laboratory Standards Institute. *Protection of Laboratory Workers From Occupationally Acquired Infections; Approved Guideline—Fourth Edition*. Wayne, PA: Clinical and Laboratory Standards Institute; 2014. CLSI Document M29-A4.
5. Clinical and Laboratory Standards Institute. *Collection of Diagnostic Venous Blood Specimens. Seventh Edition*. Wayne, PA: Clinical and Laboratory Standards Institute; 2017. CLSI Document GP41.
6. Clinical and Laboratory Standards Institute. *Tubes and Additives for Venous and Capillary Blood Specimen Collection; Approved Standard-Sixth Edition*. Wayne, PA: Clinical and Laboratory Standards Institute; 2017. CLSI Document GP39-A6.
7. Clinical and Laboratory Standards Institute. *Procedures for the Handling and Processing of Blood Specimens for Common Laboratory Tests; Approved Guideline—Fourth Edition*. Wayne, PA: Clinical and Laboratory Standards Institute; 2010. CLSI Document GP44-A4.